

DE VOR DEM BEGINN DES ZUSAMMENBAUS FOLGENDE HINWEISE GENAU LESEN.  
 EN READ THE INSTRUCTION CAREFULLY BEFORE ASSEMBLING  
 PL PRZED ROZPOCZĘCIEM MONTAŻU ZAPOZNAĆ SIĘ Z INSTRUKCJĄ  
 FR LISEZ LES INSTRUCTIONS AVANT DE COMMENCER L'ASSEMBLAGE

# MANHATAN – korpus

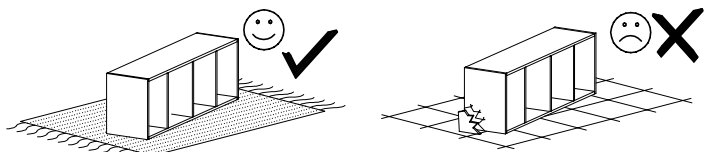

DE AUF EINEM WEICHEN UNTERGRUND, WIE TAGESDECKE ODER TEPPICH ZUSAMMENBAUEN  
 EN ASSEMBLE ON SOFT SURFACE LIKE A CARPET OR BLANKET  
 PL MONTOWAĆ NA MIEKKIM PODŁOŻU TYPU: KOC, DYWAN.  
 FR POSE SUR UN SUPPORT MOU DU TYPE : COUVERTURE, TAPIS.

DE Holzteile und deren Kontaktflächen mit der Laminatplatte nur mit einem weichen Tuch reinigen.

EN Wood components and contact points of the elements with the laminated plate cleaned only with a soft cloth. Protect from moisture.

PL Elementy drewniane oraz miejsca styku tych elementów z płytą laminowaną czyścić tylko miękką szmatką. Chronić przed wilgocią.

FR Les éléments en bois et leurs points de contact avec le panneau stratifié ne doivent être nettoyés qu'avec un chiffon doux. Protéger contre l'humidité.

DE Notwendiges Montagewerkzeug (nicht im Lieferumfang enthalten).  
 EN Tools required for assembly (not provided by the manufacturer)  
 PL Narzędzia niezbędne do montażu (nie dostarczane przez producenta)  
 FR Outillage nécessaire au montage (non fourni par le constructeur)

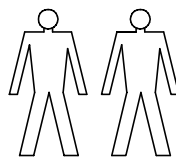
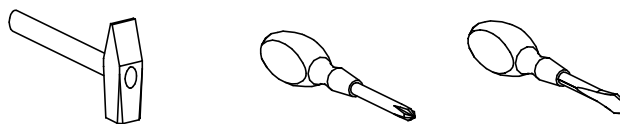

DE BEI BESCHWERDEN UND BEANSTANDUNG STETS DIE SERIENNUMMER VOM ETIKETT AUF DER VERPACKUNG ANGEBEN.

EN IN CASE OF COMPLAINT PLEASE INDICATE THE SERIAL NUMBER DESCRIBED ON THE PACKAGE LABEL.

PL W PRZYPADKU REKLAMACJI PROSZĘ OZNACZYĆ NUMER SERII OPISANY NA ETYKIECIE OPAKOWANIA

FR EN CAS DE RÉCLAMATION, VEUILLEZ MARQUER NUMÉRO DE LOT VOIR SUR L'ÉTIQUETTE DE L'EMBALLAGE

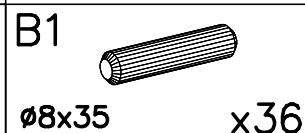
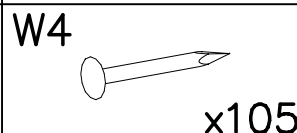
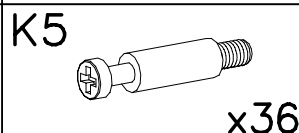
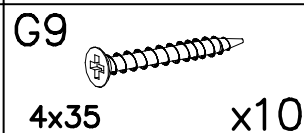
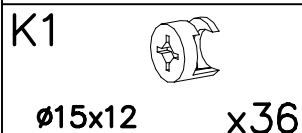
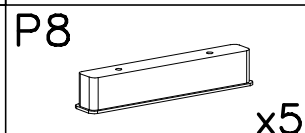
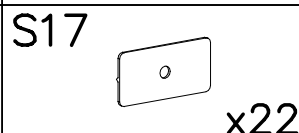
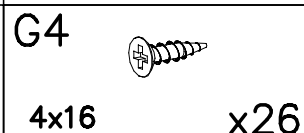
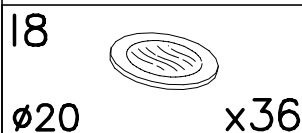
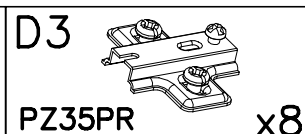
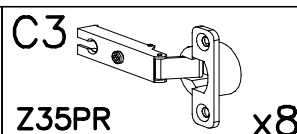
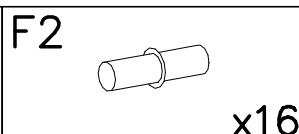
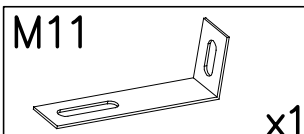
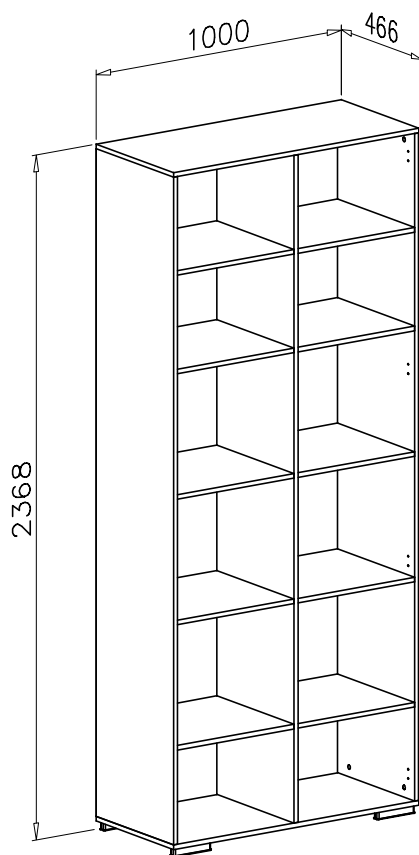

1

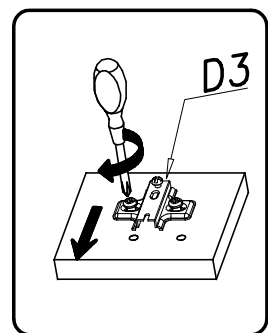
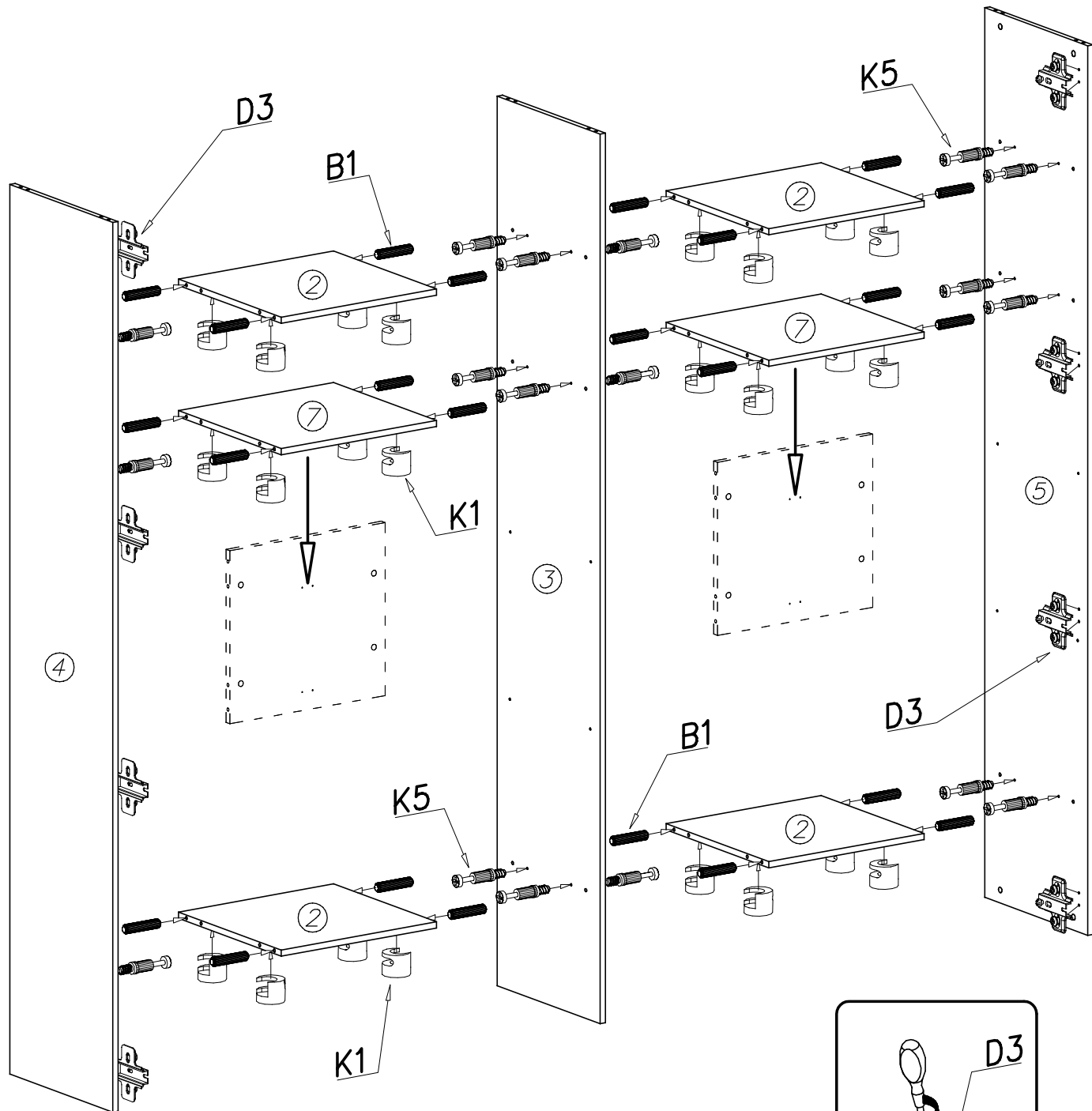
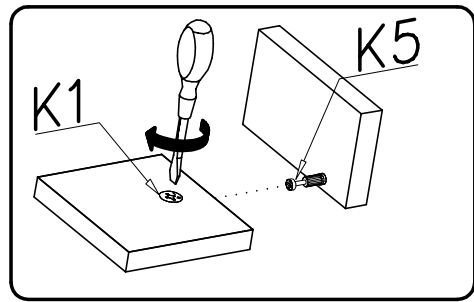
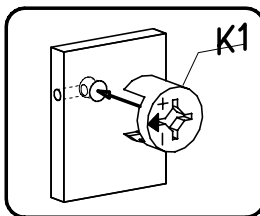
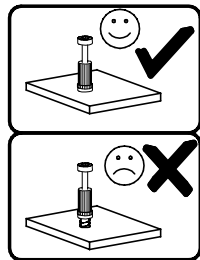
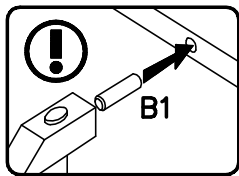

ACHTUNG  
ATTENTION  
UWAGA  
ATTENTION

Setzen Sie die Stifte an den mit Pfeilen markierten Stellen ein. Die Länge des hervorstehenden Stiftes nach dem Einschlagen in das Loch darf 9–10 mm nicht überschreiten.  
Pins to tap the space indicated by arrows. The length of the projecting pin when pocketed does not exceed 9–10 mm  
Kołki nabijać w zaznaczone strzałkami miejsca. Długość wystającego kołka po wbiciu w otwór nie może przekraczać 9–10mm.  
Insérez les chevilles dans les endroits marqués par des flèches. La longueur de la goupille saillante après avoir martelé dans le trou ne doit pas dépasser 9–10 mm.

2

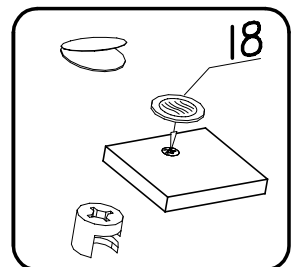
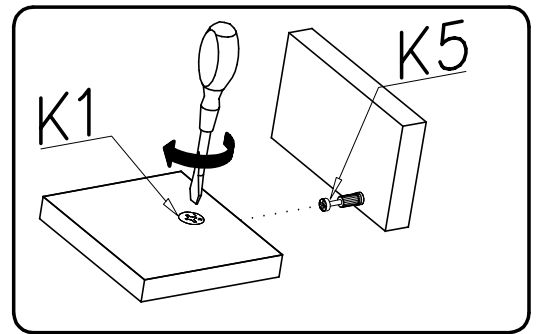
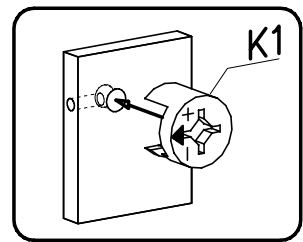
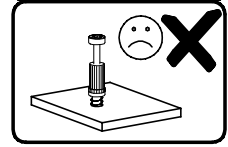
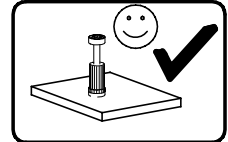
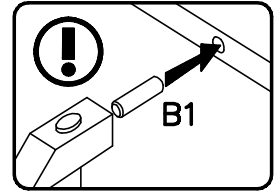
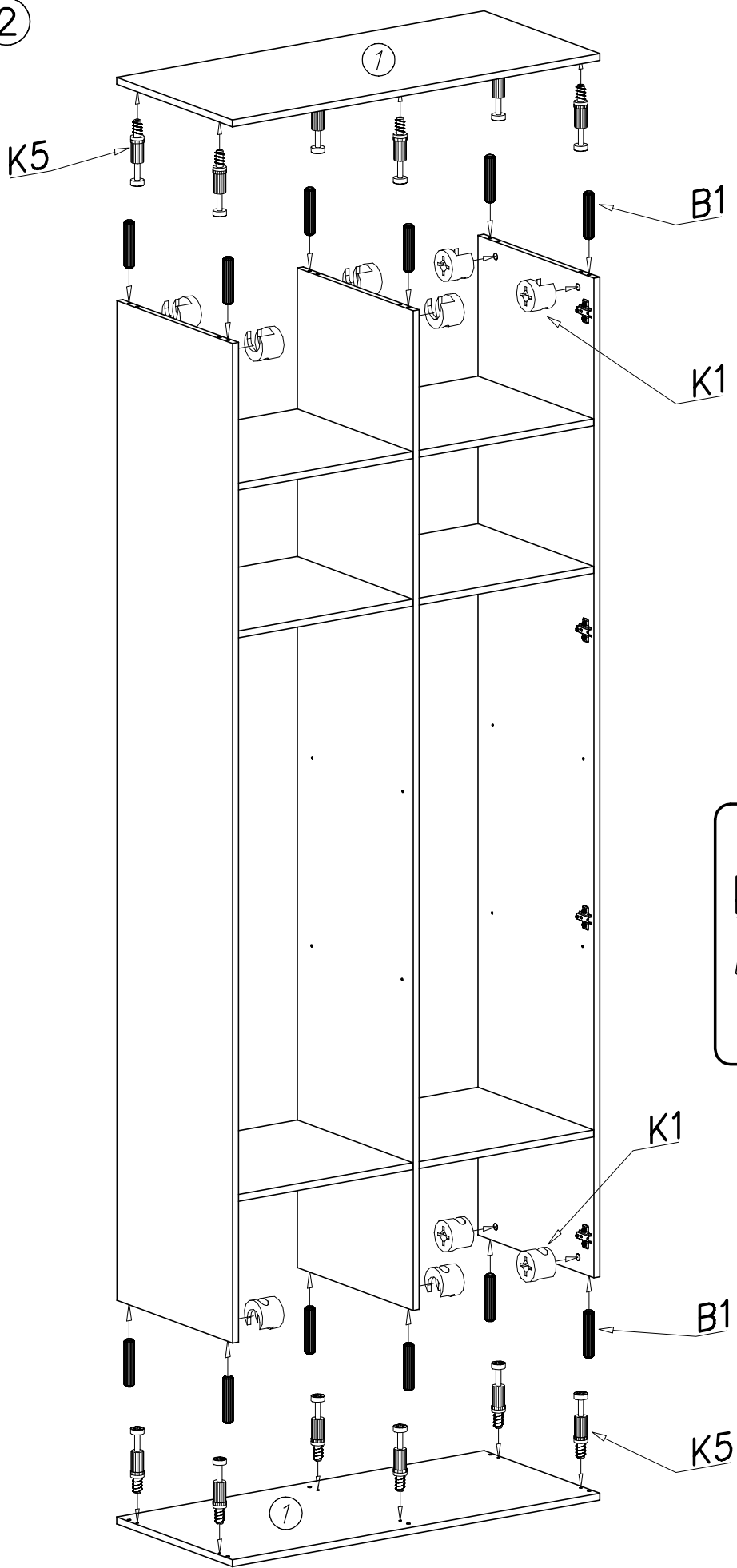

ACHTUNG  
ATTENTION  
UWAGA  
ATTENTION

Setzen Sie die Stifte an den mit Pfeilen markierten Stellen ein. Die Länge des hervorstehenden Stiftes nach dem Einschlagen in das Loch darf 9–10 mm nicht überschreiten.  
 Pins to tap the space indicated by arrows. The length of the projecting pin when pocketed does not exceed 9–10 mm  
 Kołki nabijać w zaznaczone strzałkami miejsca. Długość wystającego kołka po wbiciu w otwór nie może przekraczać 9–10mm.  
 Insérez les chevilles dans les endroits marqués par des flèches. La longueur de la goupille saillante après avoir martelé dans le trou ne doit pas dépasser 9–10 mm.

3

$$a = b$$

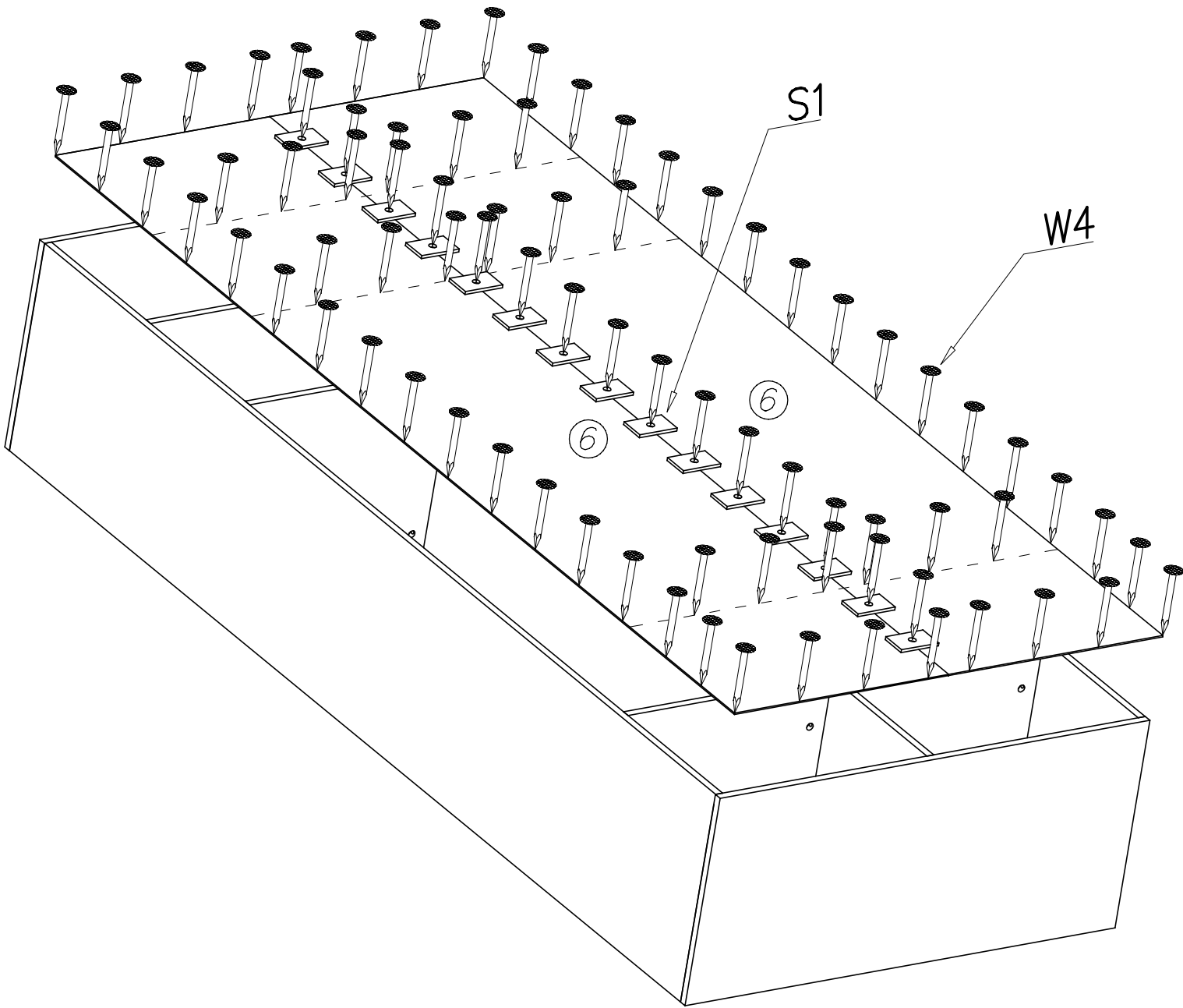
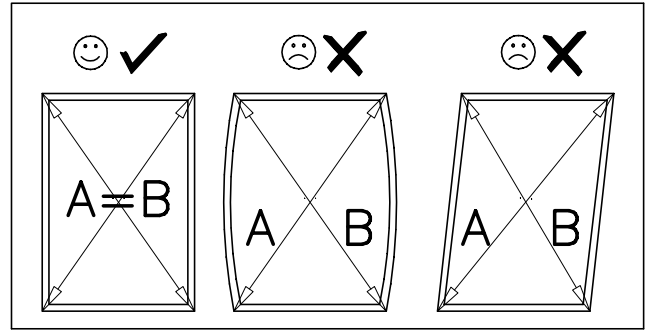
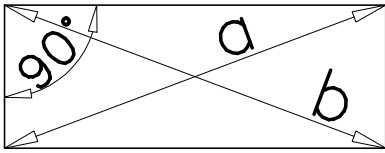

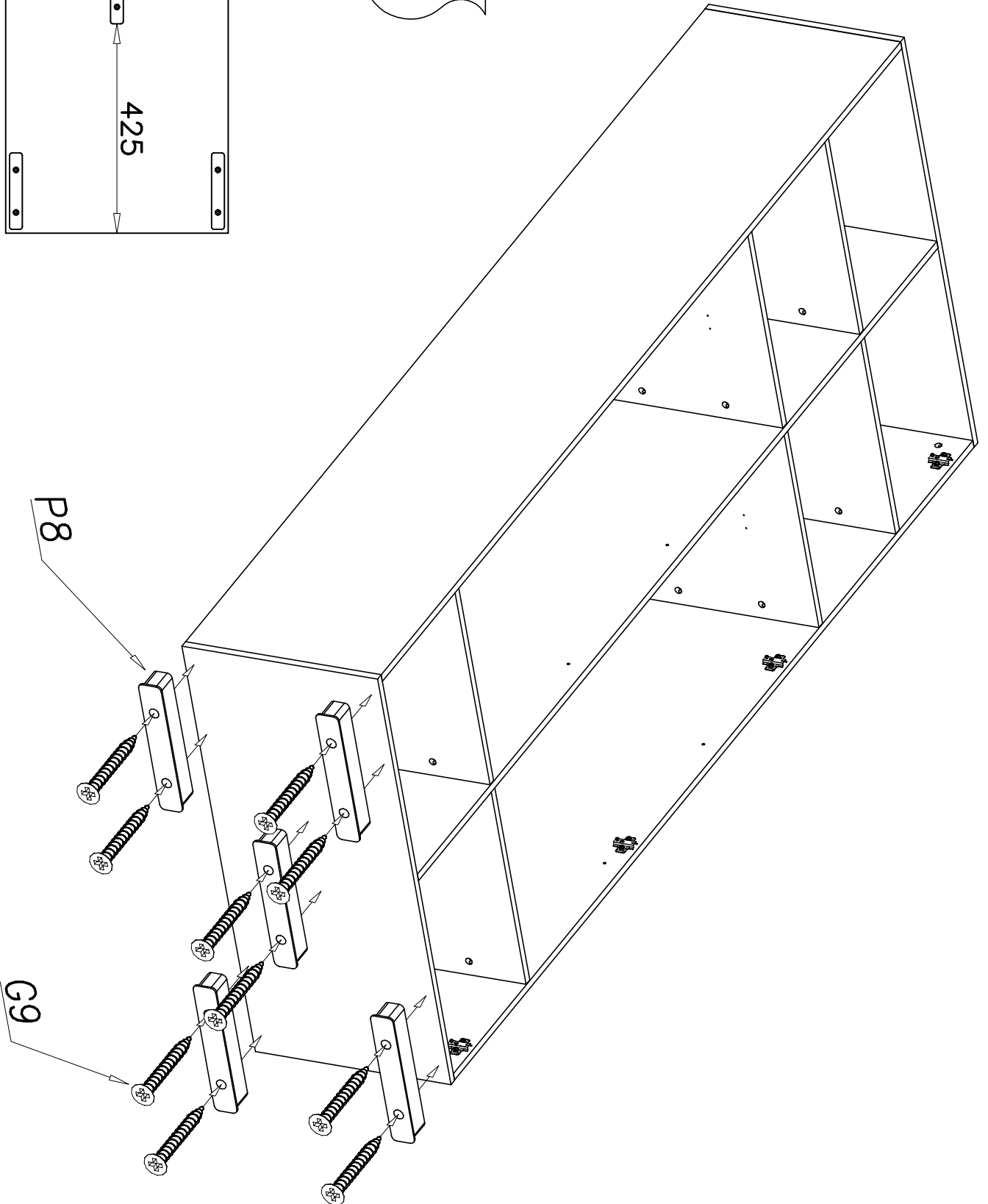
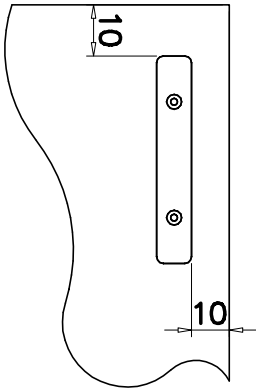
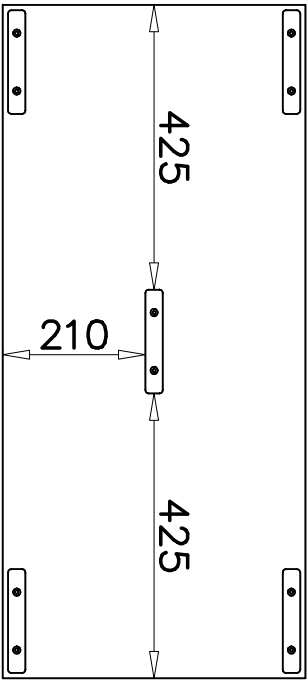

5

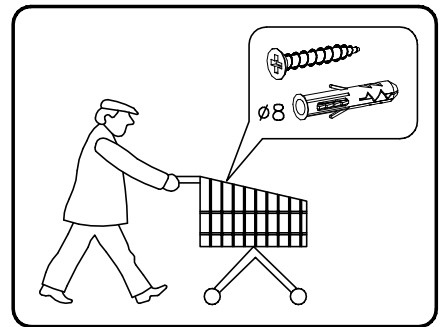
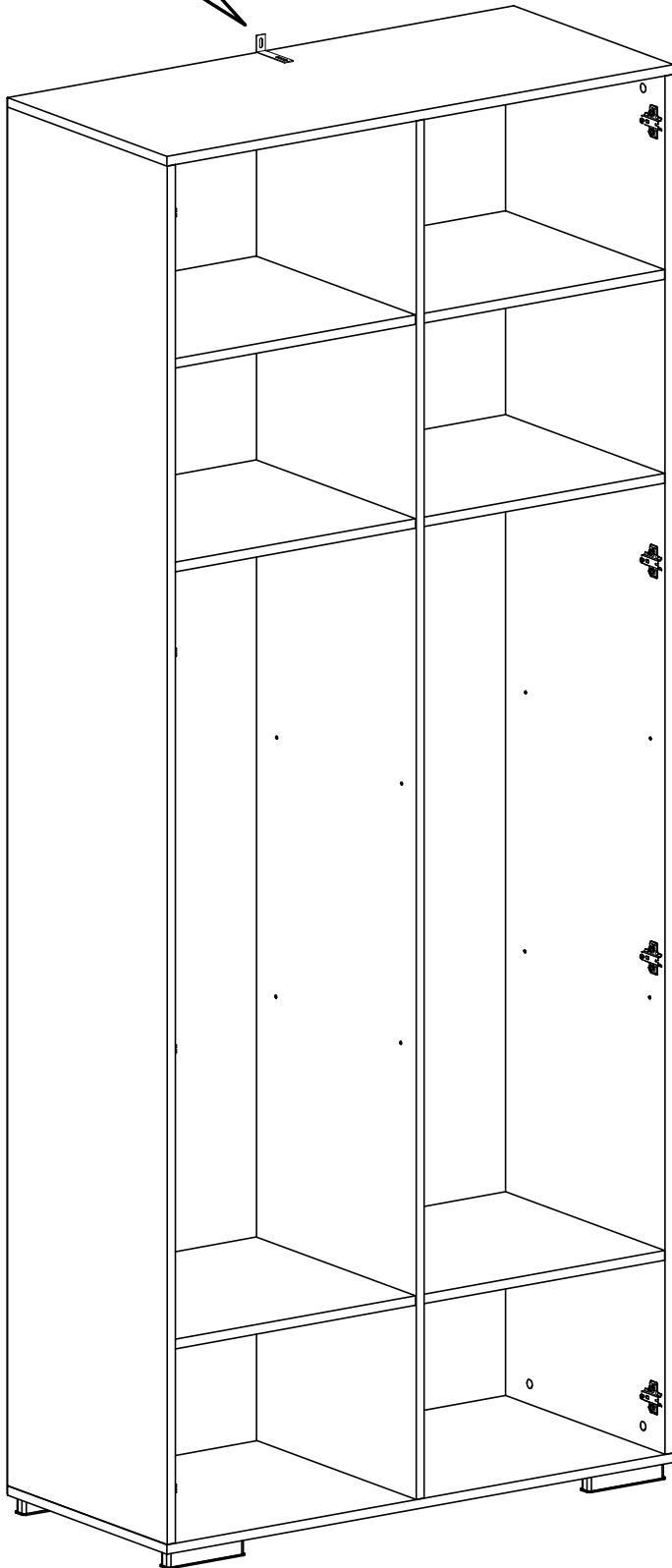
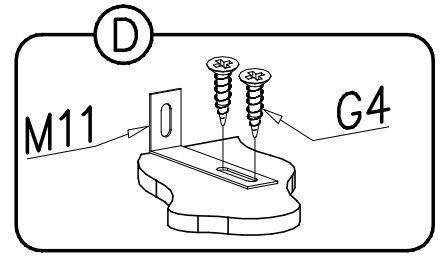
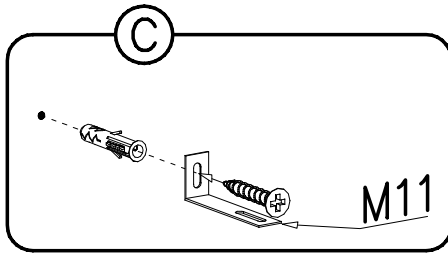
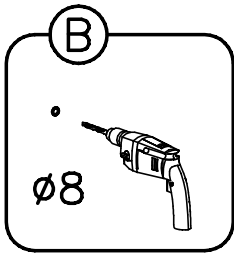
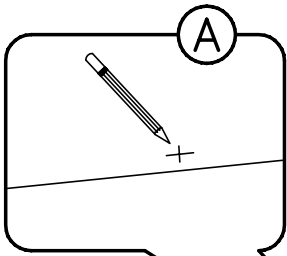

6

# OPCJA A wieszaki

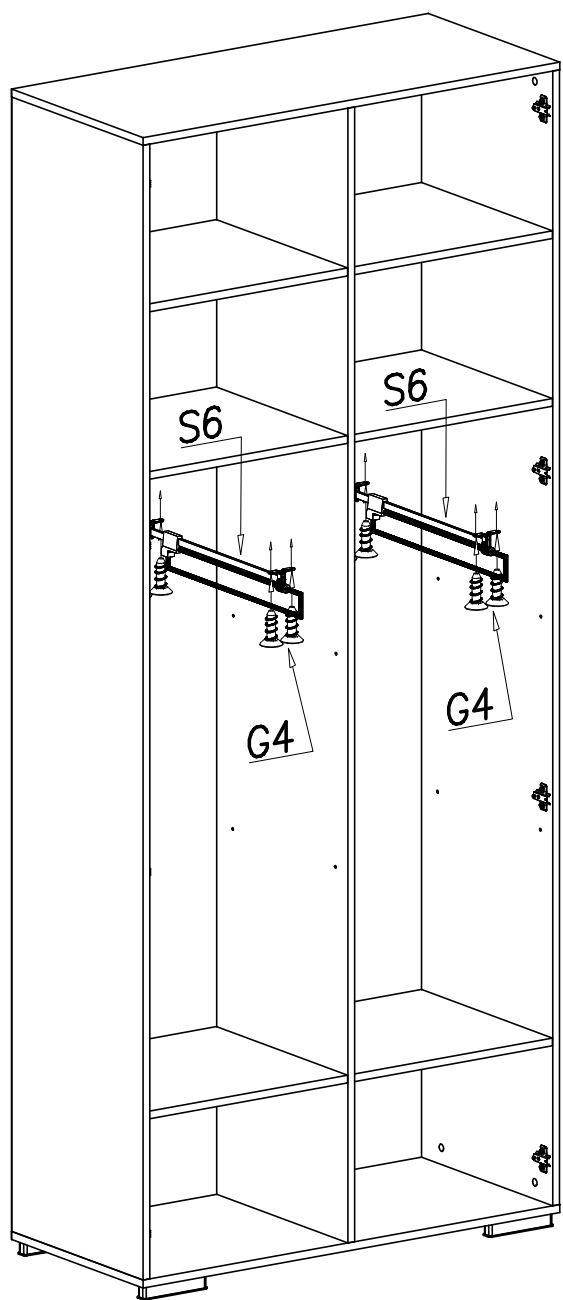

# OPCJA B półki

